

# 7UHQFK %DUULHU 6FKRWWN\ 5HFW

## Features

- Advanced trench technology
- Low forward voltage drop
- Low power losses
- High efficiency operation
- Lead Free Finish, RoHS Compliant

## Applications

- DC/DC Converters
- AC/DC Adaptors
- Switching Power Supplies
- Freewheeling Diodes

### Maximum ratings and electrical characteristics (TJ = 25°C unless otherwise noted)

Parameter	Symbol	Limit	Unit
Maximum repetitive peak reverse voltage	VRRM		V
Maximum average forward rectified current	IF(AV)		A
Peak forward surge current 8.3 ms single half sine- wave superimposed on rated load per diode	IFSM		A
Operating junction and storage temperature range	TJ, TSTG	- to +150	
7\SLFDO WKHUPDO UHVLVWDQFH SHU GLSHG 1 ORXQWHG RQ )5 3 &AW			
Instantaneous forward voltage per diode	VF(1)	TYP.	0.5
		IF= 1 A TJ=25°C	0.5
		IF= 1 A	0.5
Instantaneous reverse current per diode at rated reverse voltage	IR(2)		uA

Notes:

3XOVH WHVW 3XOVH ZLGWK GXW\ F\FOH  
 3XOVH WHVW 3XOVH ZLGWK 0

**RATINGS AND CHARACTERISTICS CURVES (TA = 25 °C unless otherwise noted)**

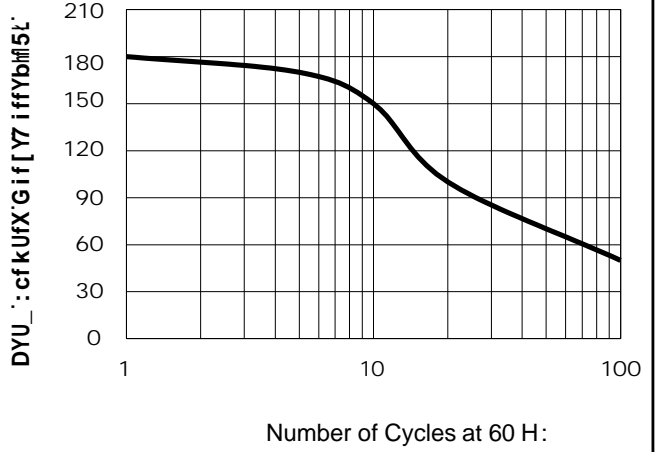
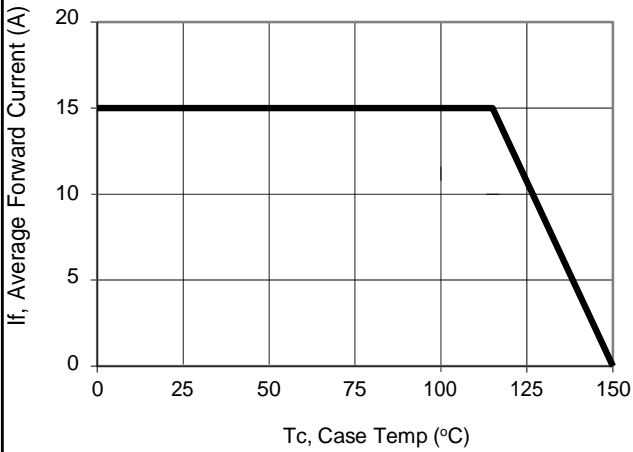
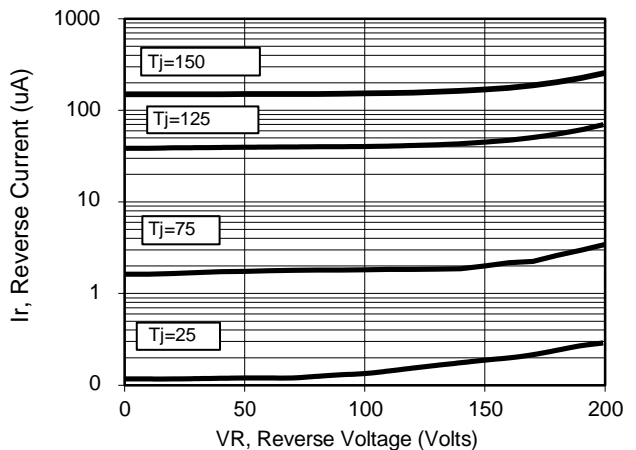
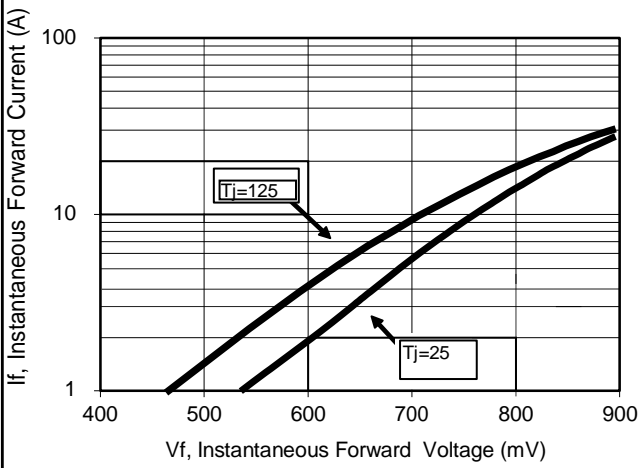
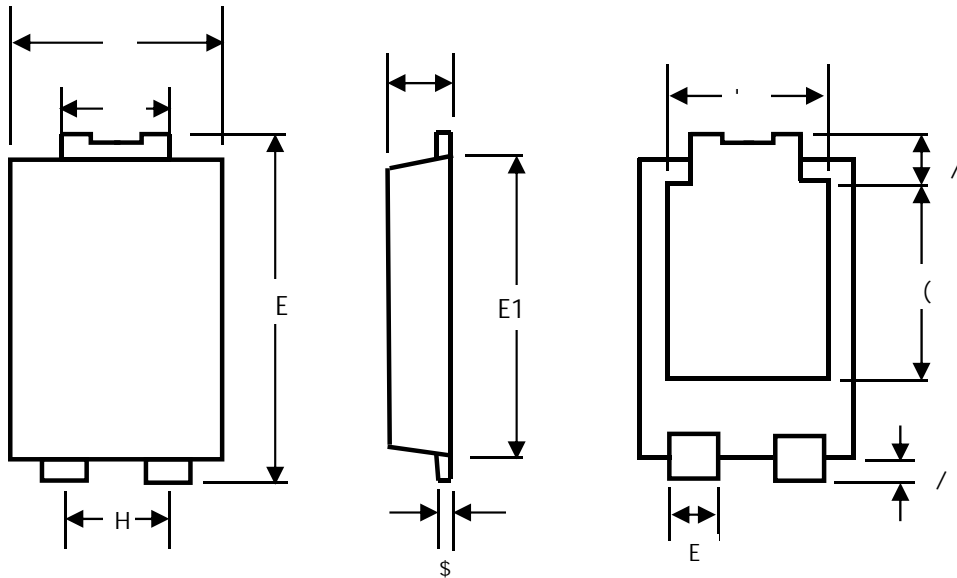

Figure2: Maximum Repetitive Surge Current





**TO-277 Mechanical Data**

UNIT		A	A2	1	2	D	D1	E	E1	E2	L	L1
mm	max	13	0	10	1	3	3.05		)	7)	%"	\$
	min											
mil	max	51.1	15.75	3.37	7.0	1.3	120.0	25	22.0	%"	-	7
	min											

**TO-277 Gi [ [YghYX'DUX'@Umc i h**

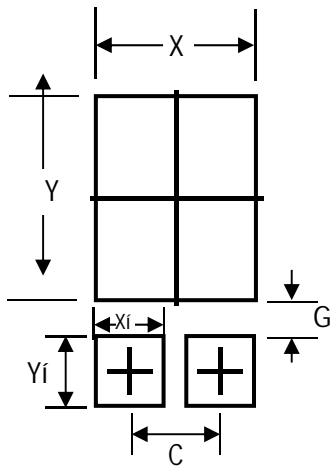

IB-T	7	;	L	L%	<	<
a a	a]b	%, \$	\$-\$	'" (	%" (	
a]	a]b	7, ", *	' ) ('	%' "' , *	' ) ('	

## Marking Information

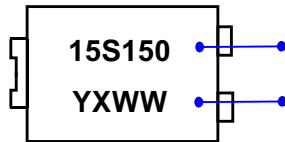

Product model :TSP15Ü150SP Referred to as 15Ü150

PDC information

Y X WW

WW:Week code(01 to 53)

X:Internal identification code

Y:Year code(ex:0=2020)

## Packaging Information

### 1.Reel Dimensions

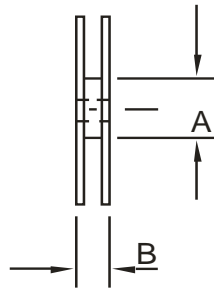
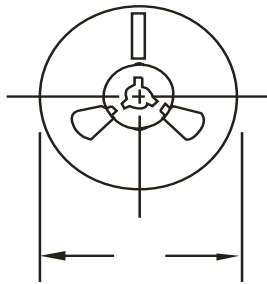

### 2. Inside Box

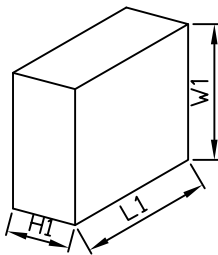

### 3. Outside Box

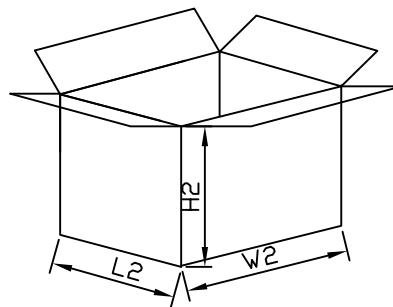

## Packaging Information

NO	UNIT	Reel Dimensions			Inside Box			Outside Box		
			A	B	L1	W1	H1	L2	W2	H2
Size	mm	330	70	15	335	335	43	360	360	360
QTY	PCS	Smallest package,5000PCS/reel			10,000PCS,2 reel in total			80,000PCS/carton,8 boxes in total		
Note	Tolerance 20mm,±3mm; 21-100mm,±5mm; 101-500mm,±10mm									