

7UHQFK 026 %DUULHU 6FKRWWN\ 5H

763 9 63  
TO-277

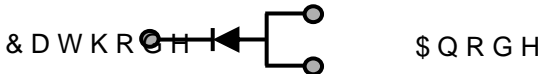

)HDWXUHV  
 ‡ \$GYDQWUHQFK WHFKQRORJ\  
 ‡ /RZRUZVROWDJH GURS  
 ‡ /RZRZURVVHV  
 ‡ +LJHILFLHQF\ RSHUDWLRQ  
 ‡ /HDGH)HLQLVK &RPSOLDQW

\$SSOLFDFWLRQV  
 ‡ '&' &RQYHUWHUV  
 ‡ \$\$ '&\$GDSWRUV  
 ‡ 6ZLWFKRZHXSSOLHV  
 ‡ )UHHZKHHLRGLJ

0D[LPXP UDWLQJV DQG HOHFWULFDJ& FXODDWHVHUQRWHIGFV

3DUDPHWHU		6\PERO	/LPLW	8QLW
0D[LPXP SHSHVSHUNYHYURQWDJH		9550		9
0D[LPXPYHUDRUHZDUG UFXEWHIQWG		,) \$9		\$
3HDN IRVZDUEBUUHQW VLKDDHQZDYH VXSHULP&QDWHORSEGLRGH		,) 60	0	\$
2SHUDMXQDQGLQWRUDJH WDESHUDW XOH 767			WR	f &
7\SLFDO WKHUPDO UHVLVWDQFH SHU		GL5&H	ORXQWHG RQ )5	3&f% :
,QVWDQWDQHRROWRUJZDUG SHGLRGH	,) \$	7- f &	7 < 3	0\$;
	,) \$	7- f &		
	,) \$	7- f &		8
	,) \$	7- f &		
,QVWDQWDQHRXU SHOHUHQW UDWHYHYURQWDJH		7- f &		X\$
		7- f &	5	P\$

1RWHV  
 3XOVH WHVVSXOVH ZLGWK GXW\ F\FOH  
 3XOVH WHVW 3XOPH ZLGWK 0

5\$7,1\*6 \$1' &+\$5\$&7(5,67,&6 &7859(6f& XQOHVQRWKBZULYH

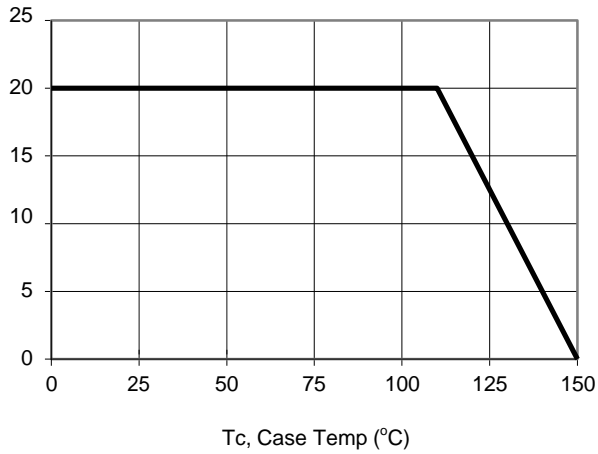

& D S D F L W S D Q F H

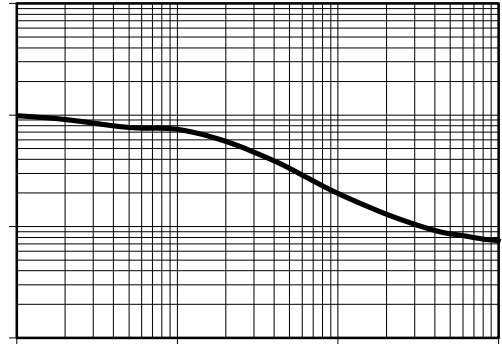

Reverse Voltage (V)

, I , Q V W D Q W J R Q Z B X X Q J U I \$ Q W

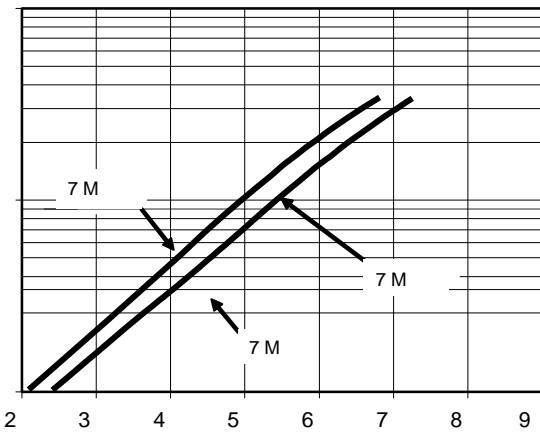

, U 5 H Y H U V V H X \$ X U U H Q W

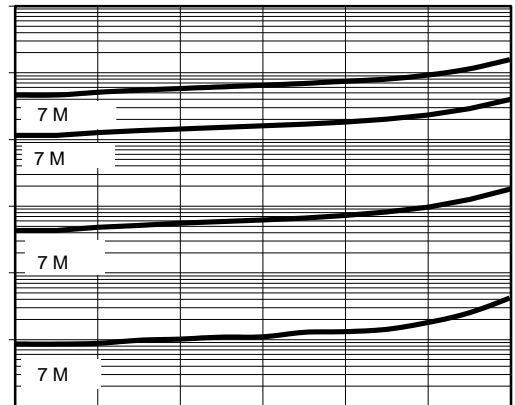

91 , Q V W D Q W D Q H R X V ) R U Z D U G 9 R O W D J H P 9 5 5 H Y H U V V H 9 R O W D J H 9 R O W V

3 \$ & . \$ \* ( 287 / , 1 ( ' , 0 ( 16 , 2 16

TO-277

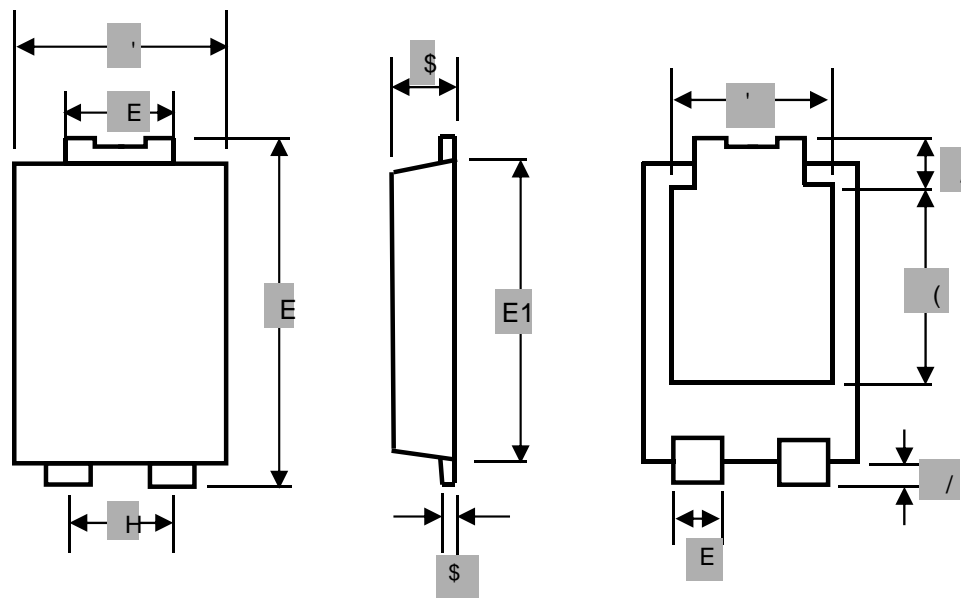

72 M H F K D Q D B W O

81,7		\$	\$	E	E	'	'	(	(	(	/	/
PP	PD[											
	PLQ											
PLO	PD[											
	PLQ											

72 6 X J J H V W D H G \ R X W

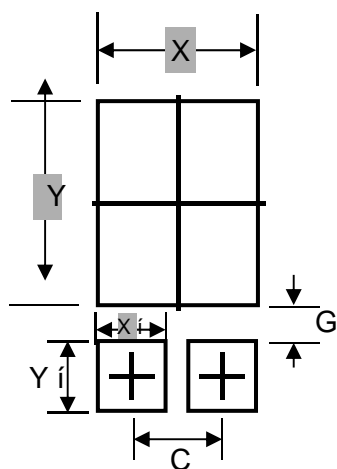

81,7		&	*	;	;	<	<
PP	PLQ						
PLO	PLQ						

0DUNLQJ ,QIRUPDWLRQ

73URGXFW PRGHO 75BIHUUU63  
WR DV 9

83' & LQIRUPDWLRQ

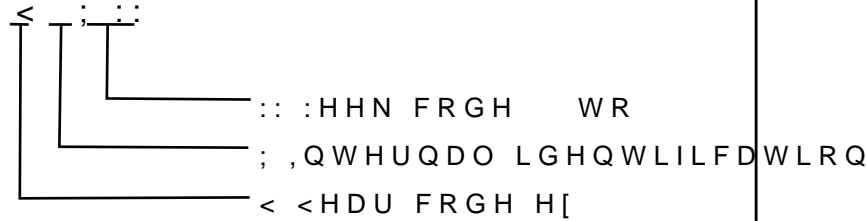
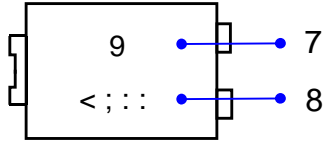

3DFNDJLQJ ,QIRUPDWLRQ

5HHO 'LPHQVLRQV

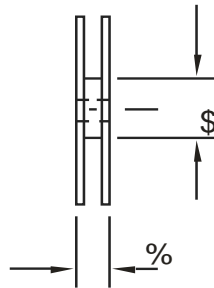
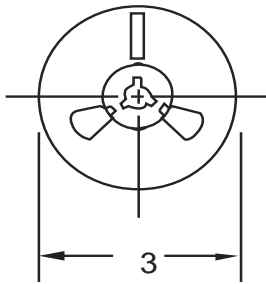

,QVLGH %R[

2XWVLGH %R[

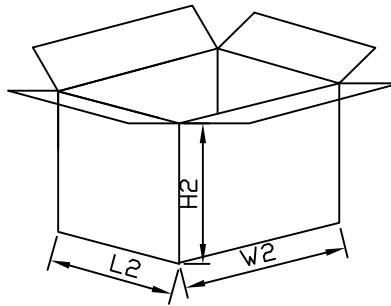
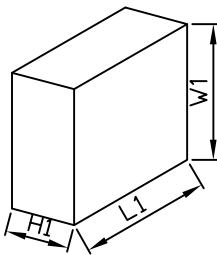

3DFNDJLQJ ,QIRUPDWLRQ

12	81,7	5HHO'PHQVLRQV			,QVLGH %R[			2XWVLGH %R[		
		&	\$	%	/	:	+	/	:	+
6L]H	PP									
47<	3&6	6PDOOHVW SDFNDJH			3&6 UHHO			3&6 UHHO		
1RWH		7ROHUDQFHP" PP			PP" PP			PP" PP		