

06% (

06% (

0\$5

6SHFLDO )RU '& \$& 5HFWLILHU %U

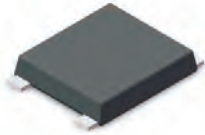

06% 3DFNDJH

3,11,1\*

3,1	'(6&5,37,21
	,QSXWÄÄ Q
	,QSXWÄÄ Q
	2XWSXWÄÄ Q RGH
	2XWSXWÄÄ W KRGH

)HDWXUHV

‡\*ODV D VVLY & KWLHKG FWLRQ

‡5HYHUVH 9ROWDJH 9

‡)RUZDUG UHQW \$

‡+LJXU & XUUH & QSD ELOLW\

‡'HVLJQH G X)RU D R X \$ S SOLFD WLRQ

%HQHILWV

‡ & DVH 6%

‡7HUPLGROGHU 0H7'

‡5HGXFHG SRZHU ORVV DQG VZLV

WUDQVLVWRU

0D[LPXP DWLQGOHFWEKDDOFWHULVWLFV

5DWLQVf & DPEL MGHV SHUXDQXUMKHU\SLHFLILHG

6LQJOH SKDVH KQ OIHZD VHU QYXK FOR D YH DSDFLWEXHU GRDWH

3DUDPHWHU	6\PEROV06% (	06% (	8QLWV
0D[LPXP 5SHWLWLYH 3HDN 59550U VH 9ROWDJH	9506		9
0D[LPXP 506 YROWDJH	9506		9
0D[LPXP '& %ORFNLQJ 9ROWDJH &			9
\$YHUDJH 5HFWLILHG 2XWSXW & RUUHQW			\$
5HYHUVH 5HFRYHU\ 7LPH ,) \$ ,5 \$ ,55 \$	7UU		QV
3HDN )RUZDUG 6XUJH & XUUHQW +DOI 6LQH :DYH 6XSHULPSRV, H60 RQ 5DWHG /RDG -('(& 0HWKRG		PV 6LQJOH RQ 5DWHG	\$
, WUDWROXVLQBV W PV	, W		\$ 6
0D[LPXP )RUZDUG 9ROWDJH DQ)			9
0D[LPXP '& 5HYHUVH & XUUHQW #7\$ DW 5DWHG '& %ORFNLQJ 9ROWDJH #7\$	f & f &		\$
7\SLFDO -XQFWLRQ & DSD FLWD & FH			S)
2SHUDWLQJ DQG 6WRUDJH 7HPSWWDWXUH 5DQJH a			f &
7\SLFDOXUHFDQV W D R Q FH	5W & 5W &		f & :

1RWH0HDVXD MG+ ] DQDSSOLLHYGHYURDWRD JH&

7KHUPDO UHVLVWDQFH IURP -XQFWLRQ WR FDVH OHDG DQG DPELHQW I  
PP PP PP \$/ SDG DWWDFK PP PP PP VWHHO SODWH

06% ( 06% ( 5HY

:RUOG ,QWH&QUDMLFLQDQ

5 \$7,1\*6 \$1' &+\$5\$&7(5,67,&6 &7859(6 XQOHVV RWKHUZLVH QRWHG

5 \$7,1\*6 \$1' &+\$5\$&7(5,67,&6 &7859(6 XQOHVV RWKHUZLVH QRWHG

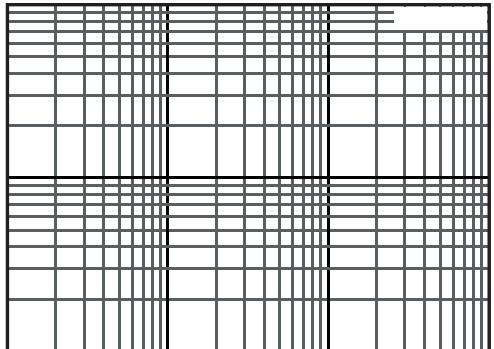

7F &DVH 7&HPS

06% ( )  
 06% ( )  
 0\$5

3\$&.\$\*(287/,1(' ,0(16,216

06%

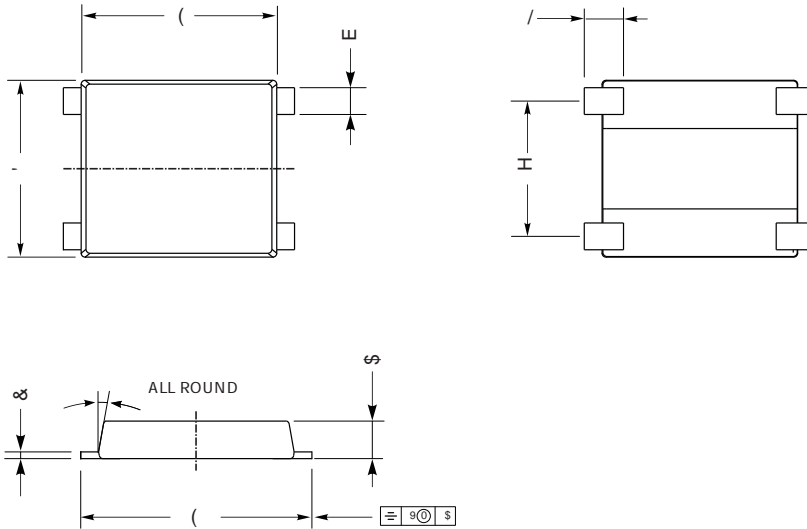

06%PHFKDGLFWO

81,7		\$	&	'	(	(	/	H	E	
PP	PD[									f
	PLQ									
PLO	PD[									
	PLQ									

06%6XJJHVWHG 3DG /D\RXW

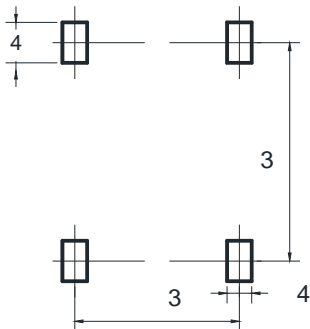

81,7		3	3	4	4
PP	PLQ				
PLO	PLQ				

'LPHQVILR/QP/LOOLPHWHUV

06% ( ) 06% ( ) 5HY

:RUOG ,QW H&JQLDQ/LFRLOVDHOG

06% ( )  
 06% ( )  
 0\$5

0DUNLQJ ,QIRUPDWLRQ

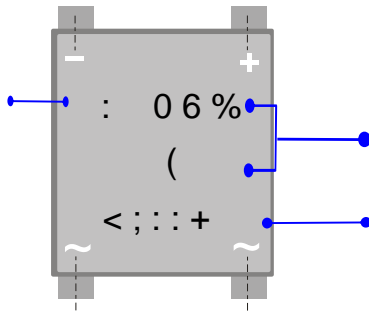

7&RPSDQ\ %UDQG :  
 83URGXFW PRGHO 06% ( RU 06%  
 93'& LQIRUPDWLRQ

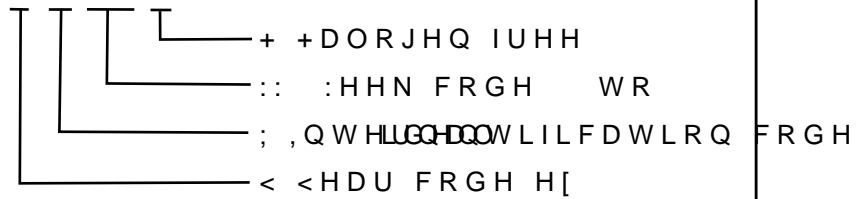

3DFNDJLQJ ,QIRUPDWLRQ

5HHO 'LPHQVLRQV

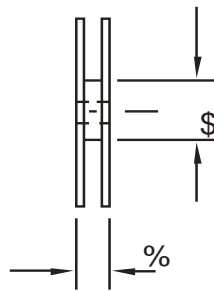
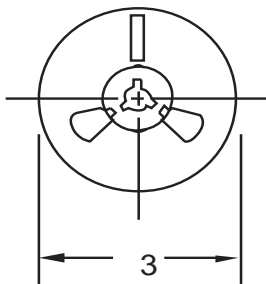

,QVLGH %R[

2XWVLGH %R[

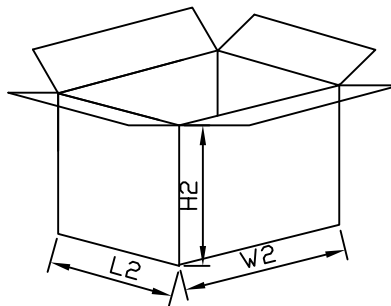
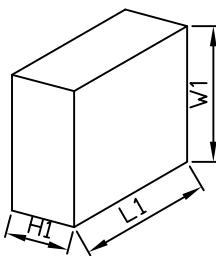

3DFNDJLQJ ,QIRUPDWLRQ

12	81,	5HHO 'LPHQVLRQV			,QVLGH %R[			2XWVLGH %R[		
		\$	\$	%	/	:	+	/	:	+
6L]H	PP									
47<	3&6	6PDOGSDVFDJH3&6 UHHO			3&6 UHHO RWDO			3&6 FDUERPRQ RWDO		
1RWH		7ROHUDQFH PP" PP			PP" PP			PP" PP		